



Models 11860-Series 11870-Series

SELF-PRIMING PUMPS ELECTRO-MAGNETIC CLUTCH UNIT

FEATURES

Body:	Bronze
Impeller:	Nitrile
Shaft:	Stainless Steel
Seal:	Carbon-Ceramic, Face Type
Ports:	11860-Series, 1" NPT Internal 11870-Series, 1-1/4" NPT Internal
Bearings:	Shielded Ball Bearings
Weight:	11860-Series, 15 lb (6.8 kg) Approx. 11870-Series, 19-1/2 lb (8.9 kg) Approx.

Model	Clutch Volt/Belt	Cam	Impeller	Insert
11860-0005	12 / 2-A	Brass	Nitrile	Brass
11860-0045	12 / 1-B	Brass	Nitrile	Brass
11860-0006	24 / 2-A	Brass	Nitrile	Brass
11860-0046	24 / 1-B	Brass	Nitrile	Brass
11870-0005	12 / 2-A	Brass	Nitrile	Brass
11870-0045	12 / 1-B	Brass	Nitrile	Brass
11870-0006	24 / 2-A	Brass	Nitrile	Brass
11870-0046	24 / 1-B	Brass	Nitrile	Brass
11870-0007	32 / 2-A	Brass	Nitrile	Brass

APPLICATION

MARINE: Pumping bilges, Washdowns, Circulating water in bait tanks, Utility dock-side pump.

INDUSTRIAL: Circulating and transferring, Velocity-mixing, Pumping machine tool coolants, Return spill, Sump drainage, Chemicals, Pharmaceuticals, Soap, Liquors, Ink, Dyes, Alcohol, Various acids, Tanning Liquors, Glycerine, Brine, etc.

FARMING: Pumping water stock, Pumping water from shallow wells and cisterns.

PLUMBING AND HOME EMERGENCY USE: Pumping out flooded basements, Cesspools, Sumps, Water heaters and water closets, Drains and sinks, Draining fishponds and pools.

PUBLIC UTILITIES AND MUNICIPALITIES: Under the hood mounting on service trucks for draining meter boxes, manholes, excavations; For pollution control and watering for dust control.

INSTALLATION

Pump may be mounted in any position. Intake and discharge ports are determined by the direction of shaft rotation (refer to dimensional drawing). Before installing, energize clutch and turn pump shaft in direction of shaft rotation. Drive pump with two "A" size belts or one "B" size belt. Avoid dry-running by using Vacuum Switch Model 4732-0000 for automatic shutoff.



Models 11860, 11870-Series

WARNING **Injury hazard. Exposed pulleys and belts can cause injury. Install shield around pulleys and belts. Stay clear while machinery is operating.**

WIRING

Connect wires as shown for manual on-off operation. Install appropriate size fuse (see Electrical Specification Chart) in positive lead as close to power source as possible. For complete wiring instruction, see diagram on last page.

Connect wires as shown for manual on-off operation.

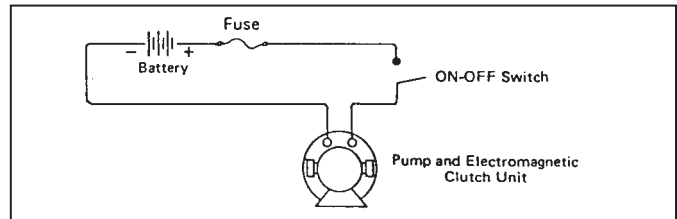

ELECTRICAL SPECIFICATIONS

Voltage	Amp Draw	Fuse Size
12	4	7
24	2	4
32	1.5	2

OPERATION

Pump will self-prime at low or high speeds. Make sure that all connections are airtight. 12 Volt models are equipped with mechanical clutch engagement screws in case of electrical failure. To mechanically engage clutch, loosen locking nuts, tighten allen head screws and retighten locking nuts. Reverse procedure to disengage clutch. If the mechanical engagement feature is not desired, the screws may be removed. **DO NOT RUN PUMP DRY FOR MORE THAN 30 SECONDS. LACK OF WATER FLOW MAY DAMAGE IMPELLER.** To drain pump, loosen end cover screws. See Head Capacity Table for head pressures and flow. To avoid costly shutdowns, keep a Jabsco Service Kit on hand.

SERVICE INSTRUCTIONS

IMPELLER REPLACEMENT: Remove end cover gasket. Pull impeller out by grasping hub with pliers. With rotary motion in the direction the pump will be turning, push the impeller into the impeller bore. A light coating of grease in the impeller bore will protect the impeller during initial dry start up. Install gasket and end cover.

SHAFT SEAL REPLACEMENT, 11870-SERIES: Remove end cover, gasket and impeller, as outlined above. Loosen cam screw several turns. Give cam screw a couple of sharp raps with the handle of the screwdriver to loosen the cam from the impeller bore. Remove the cam screw and cam (clean sealant from cam and impeller bore). Remove wearplate with hooked wire. Remove marcel washer, seal assembly and seal seat assembly from seal bore with hooked wire, taking care not to scratch shaft or seal seat bore. Clean shaft surfaces behind splines and inspect for scratches or wear. Replace if necessary. Before installing new seal parts, clean any oil or grease from carbon and ceramic seal faces. Dip seal seat and gasket assembly in water and press into seal bore with boot first. Dip carbon seal assembly in water and install over shaft, carbon towards ceramic seal seat, until it bottoms firmly against ceramic seat. Slide marcel spring washer over shaft and against the rubber boot (washer) on carbon seal assembly. Replace wearplate, aligning notch with dowel pin in body. Apply sealant to top surface of cam and cam screw threads and install cam in impeller bore. Snug up but do not tighten cam screw. Replace impeller, gasket and end cover as outlined above. Tighten end cover screws. Tighten cam screw.

SHAFT SEAL REPLACEMENT, 11860-SERIES: Refer to major repair instructions.

FIELD COIL REPLACEMENT: Remove drive belts from pulley. Remove center bolt and washer from pulley (it may be necessary to remove end cover to hold impeller from turning, while removing center pulley bolt). Tap pulley with soft mallet to remove from shaft taper. Remove 3 bolts and washers holding field coil to adaptor (11870) or body (11860). Remove and replace field coil, tightening the 3 bolts securely. With drive key in place in shaft, replace pulley assembly. Secure to shaft, replace pulley assembly. Secure to shaft with center bolt and washer (again, it may be necessary to hold the impeller from turning to tighten center bolt). Replace drive belts. Do not over tighten belts. A deflection of 1/2" midway between pulleys is generally considered normal.

MAJOR REPAIR: Remove pump from installation for major repair. Disassembly: Remove end cover, gasket, impeller, cam and wearplate as outlined in shaft seal replacement, 11870-Series. Remove clutch as outlined in field coil replacement. Model 11870-Series: Use a punch to drive roll pins (key 17) in toward shaft approximately 3/8" (10mm). Remove clutch adaptor from body. Punch roll pin out of adaptor. Model 11860-Series does not have adaptor, clutch is secured directly to body. Remove bearing to body retaining ring. Support bearing end of body on arbor press platten. Press on impeller end of shaft to remove shaft and bearing assembly from body. Use screwdriver to pry inner bearing seal from body. Take care not to scratch or damage body bore.

11860-SERIES: Remove seal seat assembly from shaft. Support impeller end of body on arbor press platten and, using suitable tube, press seal out of seal bore towards impeller end.

11870-SERIES: Remove slinger from drain area. Carbon portion of the seal assembly will be freed from shaft when shaft is removed from body. Press seal seat assembly from bearing bore end towards impeller bore. Remove bearing to shaft retaining ring. Support bearing and press on clutch drive end of shaft to remove shaft from bearing.

ASSEMBLY: Support inner race of bearing on arbor press platten. Oil shaft, insert drive end of shaft into bearing and press shaft through bearing until it bottoms firmly against shoulder. Install shaft to bearing until it bottoms firmly against shoulder. Install shaft to bearing retaining ring in groove of shaft. Support impeller bore end of pump on arbor press platten. Lubricate bearing seal with grease and press into bearing seal bore, flush with bearing bore shoulder, with lip facing away from bearing bore. For 11870-Series only: Insert slinger in drain slot, to be picked up by shaft during shaft/bearing assembly. Insert splined end

of shaft through bearing seal (and slinger on Model 11870-Series). Press on outer bearing race to assemble shaft/bearing assembly into body, bottoming bearing firmly against bearing bore shoulder. Install body to bearing retaining ring in groove in body with flat side against bearing. For 11870-Series only: Install clutch adaptor in bearing bore. If re-using adaptor previously disassembled from pump, line up dowel pin holes during assembly of adaptor to body. If installing new adaptor (which does not have pre-drilled dowel pin holes), insert into bearing bore until it bottoms and use dowel pin holes in body to pilot drill dowel pin holes through adaptor in two places, 180° apart. Clean any brass chips from bearing area. Press roll pins into body to secure adaptor. Attach field coil to adaptor (11870-Series) or body (11860-Series) with three round head bolts. Turn body over and support on field coil.

11860-SERIES: Dip seal seat assembly, consisting of ceramic seal seat and rubber washer, in water and push over shaft, with shiny side of ceramic facing impeller bore, until bottoms firmly against shaft shoulder. Press on outside edge of seal case with carbon seal face towards ceramic seat to install seal assembly in seal bore. Press flush with bottom of impeller bore.

11870-SERIES: Assemble rubber boot over ceramic seal seat so that shiny surface of seal seat is outwards. Dip assembly in water and insert into seal bore. Press firmly but carefully on seal seat until it bottoms against shoulder of seal bore. Check to see that the seal seat assembly remains in position and does not "pop" back out. A slight twisting motion while pressing will seat it firmly in position. In this pump, either a wave washer seal or coil spring carbon seal may be used. The wave washer is used only if the carbon portion of the seal does not have a coil spring attached.

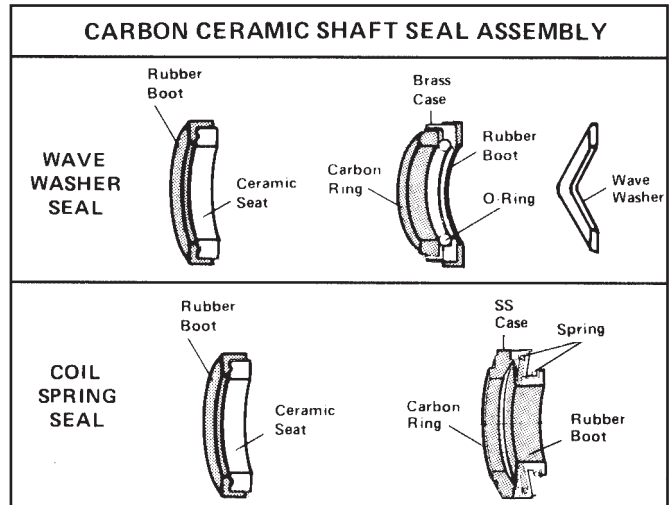

Inspect shaft and seal seat bore to be sure sealing surfaces are free of nicks or scratches. Clean shaft surface behind splines to ensure proper O-ring seal on shaft. Apply light film of grease on shaft surface behind spline area. Slide carbon ring assembly, with carbon facing ceramic, over the shaft and firmly up against the ceramic seat. If carbon portion of seal does not have an integral coil type tensioning spring, slide wave washer over the shaft and against the rubber boot on metal case containing O-ring and carbon. Install wearplate in bottom of impeller bore, locating slot in outside edge of wearplate over dowel pin in body. Apply a small amount of sealant to surface of cam and cam screw threads and install cam in impeller bore. Edge of cam should be flush with flange face of body. With a rotary motion in the direction the pump will be turning, push the impeller into the impeller bore until it is firmly bottomed. Turn body over to install clutch pulley assembly. Press key into shaft. Position clutch/pulley assembly on shaft aligning key with slot in pulley hub. Secure with bolt and washer. To tighten bolt securely, it may be necessary to hold the impeller to prevent the shaft from turning. Turn pump assembly over. Dip gasket in water, position on pump flange face, install end cover and secure with end cover screws.

EXPLODED VIEW

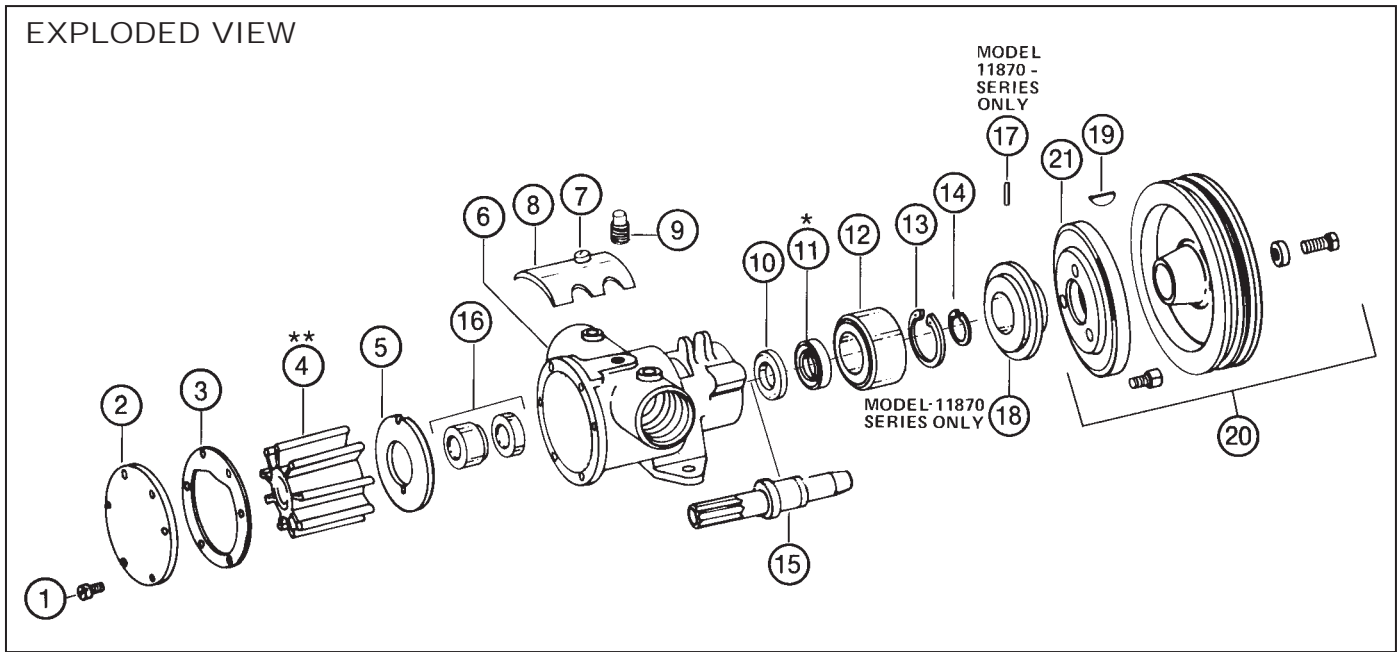

PARTS LIST

Key	Description	Qty. Req.	11860-Series Part No.	11870-Series Part No.
1	Screw End Cover (3 Per Kit)	2	91003-0010	-
	Screw End Cover (3 Per Kit)	2	-	91005-0040
2	End Cover	1	11831-0000	12062-0000
3	Gasket	1	890-0000	816-0000
4	Impeller Nitrile, Brass**	1	920-0003	836-0003
5	Wearplate	1	7868-0000	2574-0000
6	Body	1	11864-0000	18753-0585
7	Screw Cam (3 Per Kit)	1	91004-0090	91005-0040
8	Cam, Brass	1	934-0000	834-0001
9	Pipe Plug	2	92650-0070	92650-0070
10	Slinger	1	3180-0000	3181-0000
11	Seal (Bearing)*	1	913-0000	817-0000
12	Ball Bearing (Pump)	1	92600-0540	92600-0040
13	Retaining Ring (Brg to Body)	1	18724-0000	18712-0000
14	Retaining Ring (Brg to Shaft)	1	18713-0000	18711-0000
15	Shaft	1	11867-0000	11877-0000
16	Seal (Shaft)	1	96080-0080	6407-0010
17	Roll Pin (Adaptor)	2	-	93100-0160
18	Adaptor	1	-	11876-0000
19	Key (Clutch Drive)	1	91401-0100	91401-0100
20	Clutch Assy. Complete	1	92300-0030	92300-0030
	12 V - 2-A Grooves		18753-0493	18753-0493
	12 V - 1-B Groove		92300-0061	92300-0061
	24 V - 2-A Grooves		18753-0494	18753-0494
	24 V - 1-B Groove		-	92300-0050
	32 V - 2-A Grooves		-	-
21	Replacement Field Coil		98022-0500	98022-0500
	12 V		98022-2155	98022-2155
	24 V		98022-0510	98022-0510
	32 V		98022-0510	98022-0510
	Service Kit Nitrile Impeller		90118-0003	90062-0003

* Use on pre 2002 models. Date code 01H or earlier.

**Special application model 11860-7001, use Impeller 17937-0001, Service Kit 90118-0001

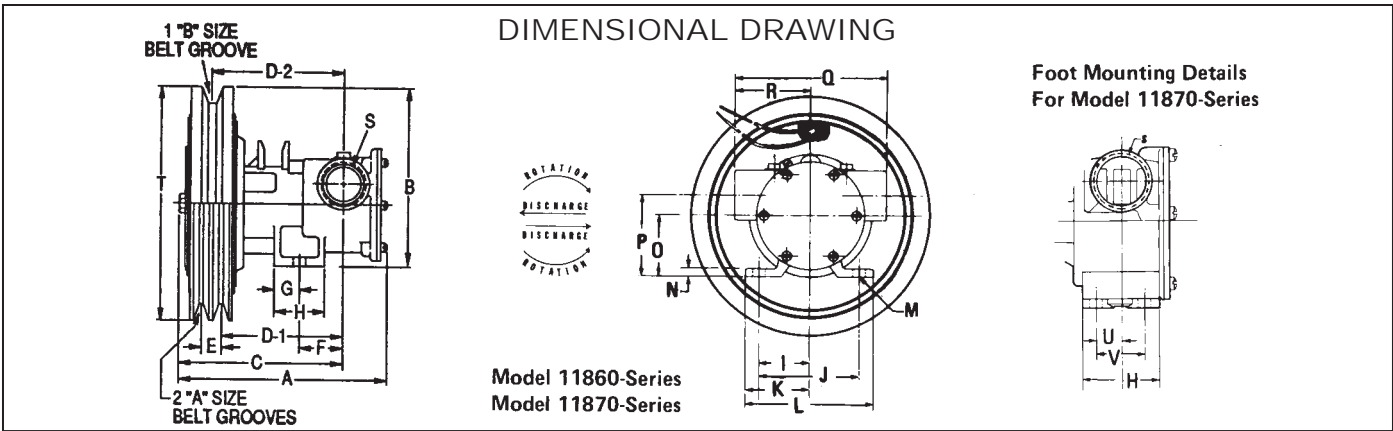

TABULATION OF DIMENSIONS (Inches and Millimeters)

Model	A	B	C	D-1	D-2	E	F	G	H	I	J	K	L	M	N	O	P	Q	R	S	T	U	V
11860 Series	6-3/16 157	5-3/8 137	4-29/32 125	3-9/16 90	3-7/8 98	5/8 16	1-5/16 33	3/4 19	1-1/2 38	1-9/16 40	3-1/8 79	2 51	4 102	13/32 10	1/4 6	1-7/8 48	2-1/2 64	4-3/4 21	2-3/8 60	1" NPT	7 178	—	—
11870 Series	8-3/16 208	6-1/16 154	7-1/16 179	5-1/4 133	5-9/16 141	5/8 16	— 31	1-7/32 59	2-5/16 57	2-1/4 57	4-1/2 114	2-3/4 70	5-1/2 140	13/32 10	5/16 8	2-9/16 65	3-13/16 97	5-7/8 149	2-15/16 75	1-1/4" NPT	7 178	3/16 21	1-1/2 38

CAPACITY TABLES

	Total Head				500 RPM			1160 RPM			1750 RPM			2450 RPM			3000 RPM		
	psi	kg per sq cm	feet of water	meters of water	GPM	LPM	HP	GPM	LPM	HP	GPM	LPM	HP	GPM	LPM	HP	GPM	LPM	HP
11860 Series	4.3	0.3	10	3.0	6.0	22.7	1/4	14.8	56.0	1/3	23.3	88.2	3/4	32.5	123.0	1	34.8	131.7	1-1/2
	8.7	0.6	20	6.1	5.5	20.8	1/4	14.1	53.4	1/2	22.3	84.4	3/4	31.8	120.4	1-1/2	34.2	129.5	1-1/2
	17.3	1.2	40	12.2	4.0	15.1	1/4	12.0	45.4	1/2	19.5	73.8	3/4	28.5	107.9	1-1/2	32.5	123.0	2
	26.0	1.8	60	18.3	—	—	—	8.8	33.3	3/4	15.0	56.8	1	23.5	89.0	1-1/2	29.8	112.8	2
	34.6	2.4	80	24.4	—	—	—	—	—	—	—	—	—	17.0	64.4	1-1/2	23.8	90.1	2
11870 Series	4.3	0.3	10	3.0	18.0	68.1	1/2	41.0	155.2	1	62.0	234.7	1-1/2	—	—	—	—	—	—
	8.7	0.6	20	6.1	17.0	64.4	1/2	40.0	151.4	1	60.0	227.1	1-1/2	—	—	—	—	—	—
	17.3	1.2	40	12.2	14.0	53.0	1/2	37.0	140.1	1-1/2	55.0	208.2	2	—	—	—	—	—	—
	26.0	1.8	60	18.3	—	—	—	30.0	113.6	1-1/2	50.0	189.3	2	—	—	—	—	—	—
	34.6	2.4	80	24.4	—	—	—	—	—	—	40.0	151.4	3	—	—	—	—	—	—

WIRING DIAGRAMS

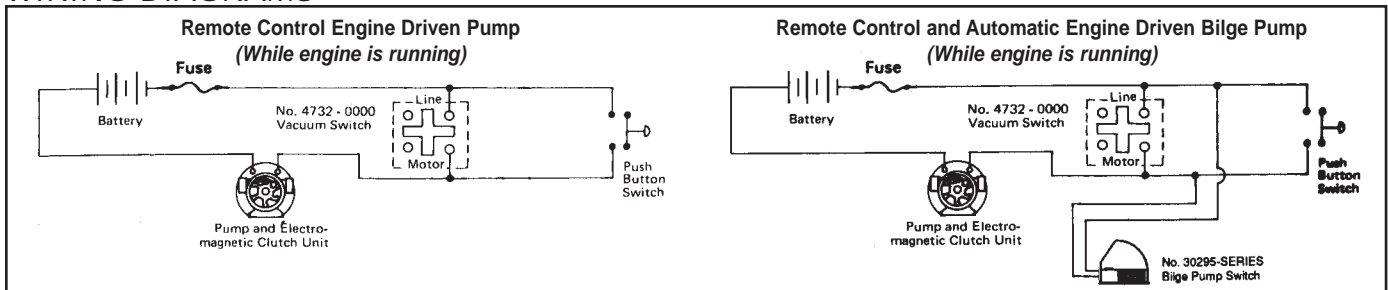

REMOTE CONTROL: Install a pushbutton switch at one or more locations (multiple switches should be wired parallel). Depress pushbutton for 2 seconds. If there is water in bilge, pump will operate until dry, at which time vacuum switch will stop pump. If no water is in bilge, pump will stop when pushbutton is released.

AUTOMATIC BILGE PUMP: Install No. 30295-Series Automatic Bilge Pump Switch where it will energize clutch at maximum high water level in bilge. When water raises switch float, pump will start. Vacuum switch will maintain closed circuit until bilge is pumped dry. Pump will automatically stop, preventing impeller damage.

Jabsco



THE PRODUCTS DESCRIBED HEREIN ARE SUBJECT TO THE JABSCO ONE YEAR LIMITED WARRANTY, WHICH IS AVAILABLE FOR YOUR INSPECTION UPON REQUEST.

U.S.A.
Jabsco
20 Icon
Foothill Ranch, CA 92610-3000
Tel: 949.609.5106
Fax: 949.859.1254

UNITED KINGDOM
Jabsco
Bingley Road, Hoddesdon
Hertfordshire EN11 OBU
Tel: +44 (0) 1992 450145
Fax: +44 (0) 1992 467132

CANADA
Fluid Products Canada
55 Royal Road
Guelph, Ontario N1H 1T1
Tel: (519) 821.1900
Fax: (519) 821.2569

JAPAN
NHK Jabsco Company Ltd.
3-21-10, Shin-Yokohama
Kohoku-Ku, Yokohama, 222
Tel: 045.475.8906
Fax: 045.475.8908

GERMANY
Jabsco GmbH
Oststrasse 28
22840 Norderstedt
Tel: +49-40-53 43 73 -0
Fax: +49-40-53 53 73 -11